



Submersible Vortex Sewage Pump

Made in Taiwan



Catalogue 50 Hz

General Data/Material



Operating Conditions	Applications	Waste water and Sewage for domestic and industrial purposes
	Fluid Temperature	0 to 40 °C
Motor	Type	Dry Type
	Pole	2-pole
	Insulation	Class F
	Protection	IP68
Pump	Protection Device	Thermal Protector (single phase) Overload Protector (three phase)
	Impeller	Vortex Impeller
	Shaft Seal/Material	Double Mechanical Seal and one oil Seal
	Bearing	Double-shielded Ball Bearing

Component	Material
Cable	H07RN-F
Handle	AISI 304
Motor Cover	AISI 316
Seal Housing	AISI 316
Bracket	Cast Iron G.JL 200
Oil Chamber	AISI 316
Pump Housing	AISI 316
Impeller	AISI 316
Mechanical seal: Upper	CA/CE
Lower	Sic/Sic
Oil Seal	VITON
Shaft	AISI 316
Motor Housing	AISI 316

Characteristic curves N=2900 rpm

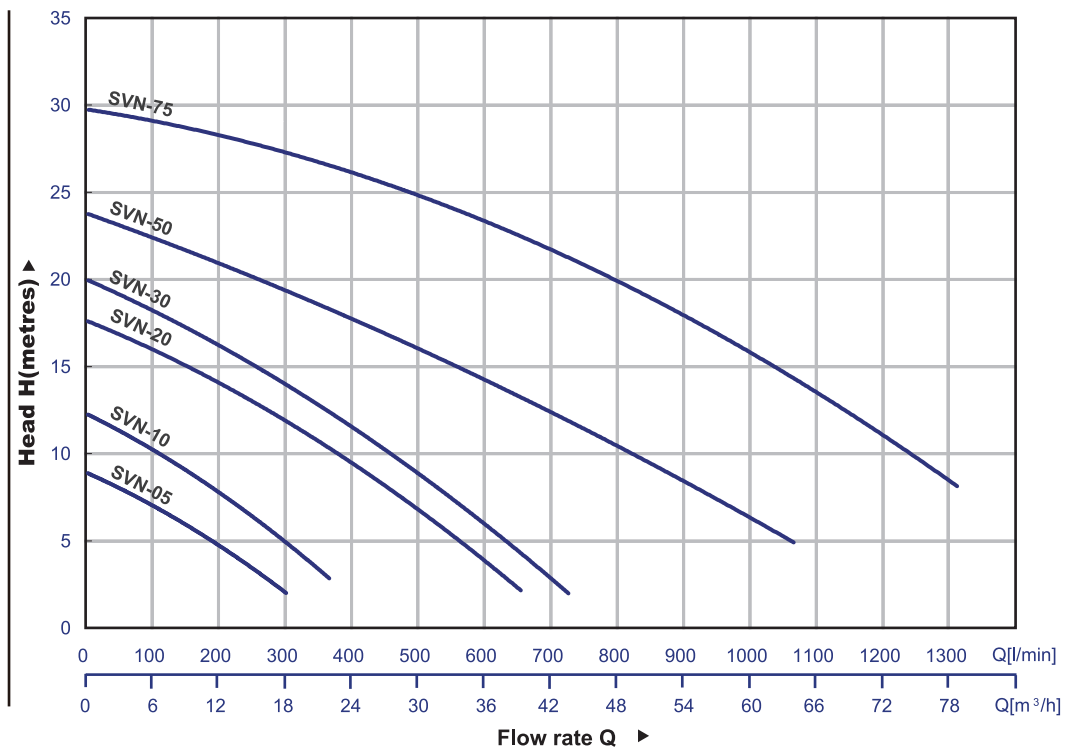

Specifications

Model	Power HP (kW)	Discharge inch	Phase	Standard		Max		Solid Passage mm	N.W. kg	Cable M
				Head M	Capacity LPM	Head M	Capacity LPM			
SVN-05-50	1/2 (0.37)	2"	1 ϕ /3 ϕ	6	150	9	300	35	13.5	10
SVN-10-50	1 (0.75)	2"	1 ϕ /3 ϕ	8	200	13	400	35	18.5	10
SVN-20-50(80)	2 (1.5)	2"/3"	1 ϕ /3 ϕ	12	300	18	700	35	34	10
SVN-30-50(80)	3 (2.2)	2"/3"	3 ϕ	13	350	20	750	35	35	10
SVN-50-80(100)	5 (3.7)	3"/4"	3 ϕ	15	550	24	1100	50	57	10
SVN-75-80(100)	7.5 (5.5)	3"/4"	3 ϕ	20	700	30	1300	50	63	10

SVN-05-50: Thread Type

SVN-10-50: Thread Type or Elbow Type (2")

SVN-20-50(80) ~ SVN-30-50(80): Elbow Type (2" or 3")

SVN-50-80(100) ~ SVN-75-80(100): Elbow Type (3" or 4")

Auto Float Switches are available in Single-phase

Dimensions and Weights

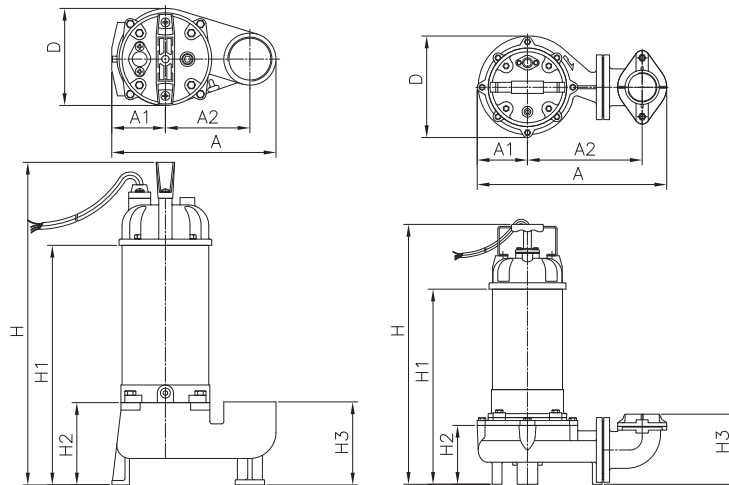

Model	Dimension (mm)							
	A	A1	A2	D	H	H1	H2	H3
SVN-05-50	224	73	115	132	409	296	112	113
SVN-10-50	224	73	115	132	439	326	112	113
SVN-20-50(80)	387	103	234	205	530	398	120	143
SVN-30-50(80)	387	103	234	205	550	418	120	143
SVN-50-80(100)	459	110	256	230	641	471	160	220
SVN-75-80(100)	459	110	256	230	681	511	160	220



www.sistema.it